

SPECIFICATIONS

PXI-5152

300 MHz Bandwidth, 2 GS/s, 8-Bit PXI Oscilloscope

Contents

Definitions.....	2
Conditions.....	2
Vertical.....	3
Analog Input (Channel 0 and Channel 1).....	3
Impedance and Coupling.....	3
Voltage Levels.....	3
Accuracy.....	4
Bandwidth and Transient Response.....	4
Spectral Characteristics.....	7
Noise.....	8
Horizontal.....	9
Sample Clock.....	9
Onboard Clock (Internal VCISO).....	9
External Sample Clock.....	9
Phase-Locked Loop (PLL) Reference Clock.....	10
Sample Clock and Reference Clock Input (PFI 0, Front Panel Connector).....	10
Reference Clock Output (PFI 1, Front Panel Connector).....	10
Trigger.....	11
Analog Trigger.....	12
Digital Trigger.....	12
External Trigger Input (Front Panel Connector).....	12
PFI 0 and PFI 1 (Programmable Function Interface, Front Panel Connectors).....	13
As an Input (Trigger).....	13
As an Output (Event).....	13
Waveform Specifications.....	14
Calibration.....	14
External Calibration.....	14
Self-Calibration.....	15
Calibration Specifications.....	15
Software.....	15
Driver Software.....	15
Application Software.....	15
Interactive Soft Front Panel and Configuration.....	15
TClk Specifications.....	15
Power.....	16

Physical.....	16
Environment.....	17
Environment.....	17
Shock and Vibration.....	17
Compliance and Certifications.....	18
Safety.....	18
Electromagnetic Compatibility.....	18
CE Compliance	19
Online Product Certification.....	19
Environmental Management.....	19

Definitions

Warranted specifications describe the performance of a model under stated operating conditions and are covered by the model warranty. *Warranted* specifications account for measurement uncertainties, temperature drift, and aging. *Warranted* specifications are ensured by design or verified during production and calibration.

Characteristics describe values that are relevant to the use of the model under stated operating conditions but are not covered by the model warranty.

- *Typical* specifications describe the performance met by a majority of models.
- *Nominal* specifications describe an attribute that is based on design, conformance testing, or supplemental testing.
- *Measured* specifications describe the measured performance of a representative model.

Specifications in this document are *Typical* unless otherwise noted.

Conditions

Specifications are valid under the following conditions unless otherwise noted.

- All filter settings
- All impedance selections
- Sample clock set to 1 GS/s
- Real-Time Interleaved Sampling (TIS) mode provides a 2 GS/s real-time sample rate for a single channel
- The module is warmed up for 15 minutes at ambient temperature
- Calibration cycle is maintained
- The PXI/PCI chassis fan speed is set to HIGH, the foam fan filters are removed if present, and the empty slots contain chassis slot blockers and filler panels. For more information about cooling, refer to the *Maintain Forced-Air Cooling Note to Users*.

Accuracy

Resolution	8 bits
DC accuracy, warranted ^{1,2}	
0.1 V to 1 V input range	$\pm(1.26\% \text{ of Input} + 1.0\% \text{ of FS} + 500 \mu\text{V})$
2 V to 10 V input range	$\pm(1.26\% \text{ of Input} + 1.0\% \text{ of FS} + 5 \text{ mV})$
Programmable vertical offset accuracy ²	$\pm 0.9\% \text{ of offset setting, warranted}$
DC Drift, nominal ³	
0.1 V to 1 V input range	$\pm(0.052\% \text{ of Input} + 100 \mu\text{V}) \text{ per } ^\circ\text{C}$
2 V to 10 V input range	$\pm(0.052\% \text{ of Input} + 1.0 \text{ mV}) \text{ per } ^\circ\text{C}$
Crosstalk	
CH 0 to/from CH 1 ⁴	
10 MHz	<-80 dB
100 MHz	<-60 dB
Ext Trig to CH 0 or CH 1 ⁵	
10 MHz	<-80 dB
100 MHz	<-80 dB

Bandwidth and Transient Response

Bandwidth (-3 dB), warranted ^{6,7}	
0.1 V input range	
50 Ω	165 MHz, typical 135 MHz minimum
1 M Ω	135 MHz, typical 110 MHz minimum

¹ Programmable vertical offset = 0 V.

² Within $\pm 5^\circ\text{C}$ of self-calibration temperature.

³ Use DC drift to calculate errors when temperature changes more than $\pm 5^\circ\text{C}$ since the last self-calibration.

⁴ Measured on one channel with test signal applied to another channel, with same range setting on both channels.

⁵ 10 V signal applied to external trigger channel. Applies to all ranges on CH 0 and CH 1.

⁶ Bandwidth for 0 to 30 $^\circ\text{C}$. Reduce by 0.25% per $^\circ\text{C}$ above 30 $^\circ\text{C}$ for all input ranges. Filter off for all input ranges.

⁷ Normalized to 51 kHz.

All other input ranges	
50 Ω	340 MHz, typical 300 MHz minimum
1 M Ω	300 MHz, typical 260 MHz minimum
Rise/fall time ⁸	
0.1 V input range	
50 Ω	2.4 ns
1 M Ω	2.8 ns ⁹
All other input ranges	
50 Ω	1.2 ns
1 M Ω	1.4 ns ⁹
Bandwidth limit filter	20 MHz noise filter
AC coupling cutoff (-3 dB) ¹⁰	
50 Ω	106 kHz
1 M Ω	12 Hz

Figure 1. PXI-5152 Frequency Response, 50 Ω , 1 V, Measured

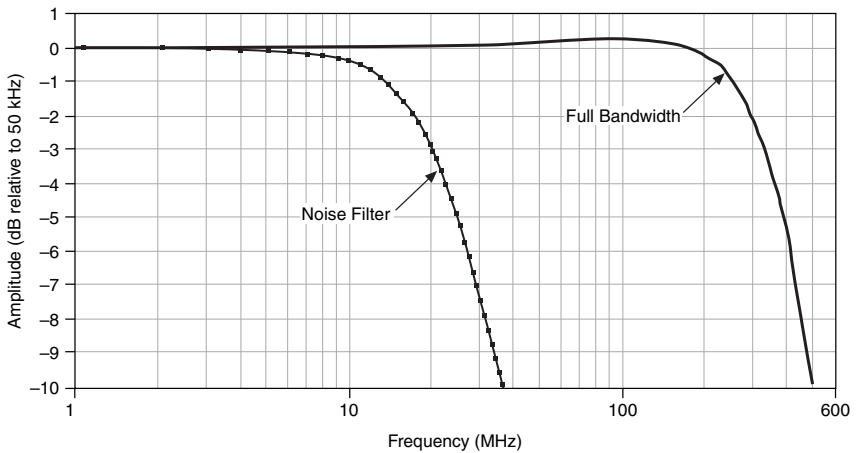

⁸ Filter off.

⁹ 50 Ω terminator connected to front panel BNC connector.

¹⁰ 50 Ω source assumed.

Figure 2. PXI-5152 Frequency Response, 50 Ω , 1 V Input Range, Measured

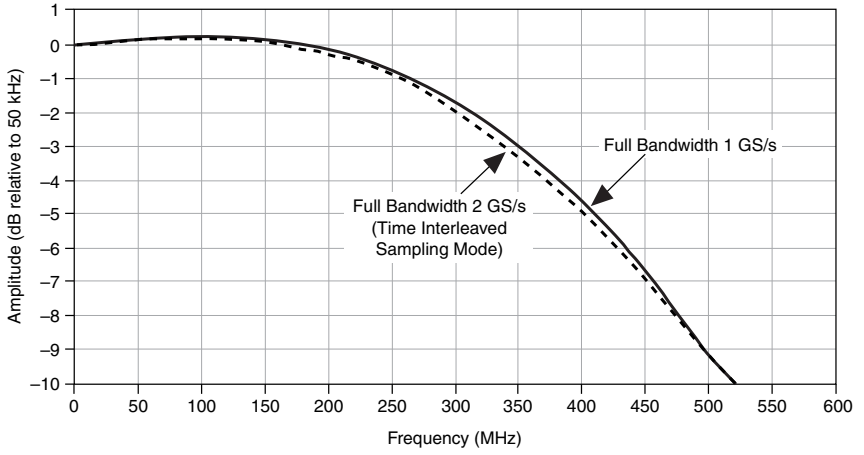

Figure 3. PXI-5152 Step Response, 50 Ω , 10 V_{pk-pk} through 0.2 V_{pk-pk} Input Range, Measured

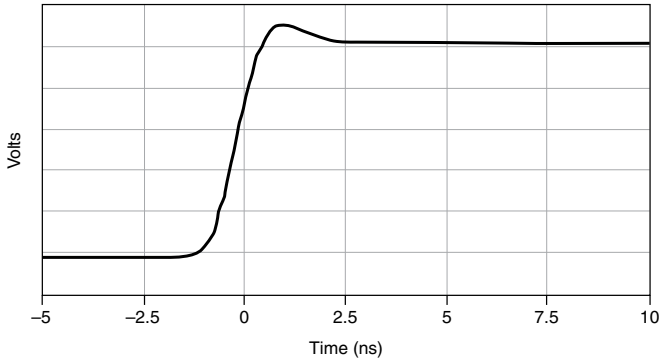
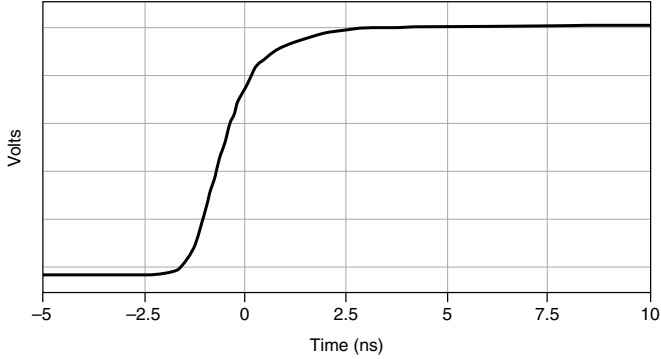

Figure 4. PXI-5152 Step Response, 50 Ω, 0.1 V_{pk-pk} Input Range, Measured



Spectral Characteristics

ENOB¹¹

Noise filter on	7.3
Noise filter off	7.1

Signal to Noise and Distortion (SINAD)¹¹

Noise filter on	45 dB
Noise filter off	43 dB

Figure 5. PXI-5152 Dynamic Performance, 50 Ω, 1 V_{pk-pk} Range, 9.425 MHz, -1 dBFS Input Signal, Measured

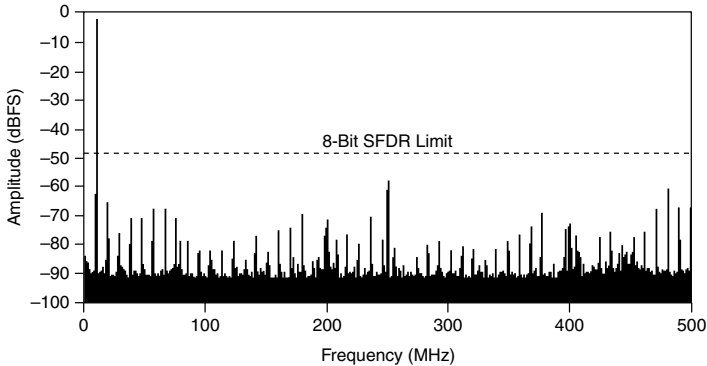

¹¹ 1 V input range, 10 MHz, -1 dBFS input signal. Includes the 2nd through the 5th harmonics.

Figure 6. PXI-5152 TIS Dynamic Performance, 50 Ω , 1 V_{pk-pk} Range, 9.425 MHz, -1 dBFS Input Signal, Measured

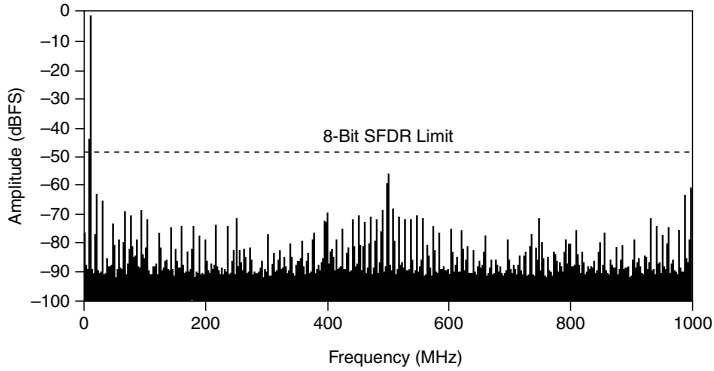

Noise

Table 2. RMS Noise¹²

Range (V _{pk-pk})	Noise Filter On	Noise Filter Off
0.1	240 μ V _{rms} (0.24% FS)	320 μ V _{rms} (0.32% FS)
0.2	480 μ V _{rms} (0.24% FS)	600 μ V _{rms} (0.30% FS)
0.4	960 μ V _{rms} (0.24% FS)	1.12 mV _{rms} (0.28% FS)
1	2.4 mV _{rms} (0.24% FS)	2.6 mV _{rms} (0.26% FS)
2	4.8 mV _{rms} (0.24% FS)	6.0 mV _{rms} (0.30% FS)
4	9.6 mV _{rms} (0.24% FS)	11.2 mV _{rms} (0.28% FS)
10	24 mV _{rms} (0.24% FS)	26 mV _{rms} (0.26% FS)

Channel-to-channel skew <100 ps

¹² 50 Ω terminator connected to input.

Horizontal

Sample Clock

Sources

Internal	Onboard clock (internal VCSO) ¹³
External	PFI 0 (front panel SMB connector)

Onboard Clock (Internal VCSO)

Sample rate range

Real-time sampling (single shot) ¹⁴	15.26 kS/s to 1 GS/s
TIS ¹⁵ mode (single shot)	2 GS/s (single channel only)
Random interleaved sampling (RIS) mode ¹⁶	2 GS/s to 20 GS/s in increments of 1 GS/s (repetitive waveforms only)

Timebase accuracy

Not phase-locked to Reference clock	±30 ppm within ±3 °C of external calibration temperature, plus an additional ±7 ppm per °C outside of ±3 °C of external calibration temperature, warranted
Phase-locked to Reference clock	Equal to the Reference clock accuracy ¹⁷

Sample clock delay range ±1 Sample clock period

Sample clock delay/adjustment resolution ≤5 ps

External Sample Clock

Sources	PFI 0 (front panel SMB connector)
Frequency range ¹⁸	350 MHz to 1 GHz
Duty cycle tolerance	45% to 55%

¹³ Internal Sample clock is locked to the Reference clock or derived from the onboard VCSO.

¹⁴ Divide by n decimation used for all rates less than 1 GS/s.

¹⁵ TIS is a type of real-time sampling that is sometimes called ping-pong.

¹⁶ RIS is a type of equivalent-time sampling.

¹⁷ Refer to your chassis specifications for the Reference clock accuracy.

¹⁸ Divide by n decimation available where $1 \leq n \leq 65,535$. For more information about the Sample clock and decimation, refer to the *NI High-Speed Digitizers Help*.

Phase-Locked Loop (PLL) Reference Clock

Sources	PXI_CLK10 (PXI backplane connector) PFI 0 (front panel SMB connector)
Frequency range ¹⁹	1 MHz to 20 MHz in 1 MHz increments Default: 10 MHz
Duty cycle tolerance	45% to 55%
Exported Reference Clock destinations	PXI_Trig <0..7> (backplane connector) PFI 1 (front panel SMB connector)

Sample Clock and Reference Clock Input (PFI 0, Front Panel Connector)

Input voltage range	Sine wave: $0.65 V_{pk-pk}$ to $2.8 V_{pk-pk}$ (0 dBm to 13 dBm)
Maximum input overload	$7 V_{rms}$ with $ Peaks \leq 10 V$
Impedance	50Ω
Coupling	AC

Reference Clock Output (PFI 1, Front Panel Connector)

Output impedance	50Ω
Logic type	3.3 V CMOS, except when exporting 5 V
Maximum drive current	$\pm 24 mA$

¹⁹ The PLL Reference clock frequency must be accurate to ± 50 ppm.

Trigger

Trigger types ²⁰	Edge Window Hysteresis Video Digital Immediate Software
Trigger sources	CH 0 CH 1 TRIG PFI <0..1> PXI_Trig <0..6> PXI Star Trigger Software
Time resolution	
Onboard clock, time-to-digital conversion circuit (TDC) on	5 ps
Onboard clock, TDC off	1 ns
External clock, TDC off	External clock period
Minimum rearm time ²¹	
TDC on	8 μs
TDC off	1 μs
Holdoff	From rearm time up to $[(2^{32} - 1) \times \text{Sample clock period}]$
Trigger delay	From 0 up to $[(2^{35} - 1) - \text{Posttrigger samples}] \times (1/\text{Sample rate})$, in seconds

²⁰ Refer to the following sources and the *NI High-Speed Digitizers Help* for more information about which sources are available for each trigger type.

²¹ Holdoff set to 0. Onboard Sample clock at maximum rate.

Analog Trigger

Trigger types	Edge Window Hysteresis
Sources	CH 0 (front panel BNC connector) CH 1 (front panel BNC connector) TRIG (front panel BNC connector)
Trigger level range ²²	
CH 0, CH 1	100% FS
TRIG (External trigger)	±5 V
Voltage resolution	8 bits (1 in 256)
Trigger level accuracy ²³	
CH 0, CH 1	±5% FS up to 10 MHz, warranted
TRIG (External trigger)	±1 V (±10% FS) up to 10 MHz, warranted
Edge trigger sensitivity ²² , warranted	
CH 0, CH 1	10% FS
TRIG (External trigger)	1.0 V _{pp}
Trigger jitter ²³	≤10 ps _{rms} , typical ≤20 ps _{rms} , maximum
Trigger filters	
Low frequency reject (LF)	50 kHz
High frequency reject (HF)	50 KHz

Digital Trigger

Trigger type	Digital
Sources	PXI_Trig <0..6> (backplane connector) PFI <0..1> (front panel SMB connectors) PXI Star Trigger (backplane connector)

External Trigger Input (Front Panel Connector)

Connector	BNC
Impedance	1 MΩ in parallel with a nominal capacitance of 22 pF

²² DC to 300 MHz.

²³ Within ±5 °C of self-calibration temperature.

Coupling	AC, DC
AC coupling cutoff (-3 dB)	12 Hz
Input voltage range	±5 V
Maximum input overload	Peaks ≤42 V

PFI 0 and PFI 1 (Programmable Function Interface, Front Panel Connectors)

Connector	SMB jack
Direction	Bidirectional

As an Input (Trigger)

Destination	Start trigger (acquisition arm) Reference (stop) trigger Arm reference trigger Advance trigger
Input impedance	150 kΩ, nominal
V _{IH}	2.0 V
V _{IL}	0.8 V
Maximum input overload	-0.5 V to 5.5 V
Maximum frequency	25 MHz

As an Output (Event)

Sources	Start trigger (acquisition arm) Reference (stop) trigger End of record Done (end of acquisition) Probe compensation ²⁴
Output impedance	50 Ω
Logic type	3.3 V CMOS
Maximum drive current	±24 mA
Maximum frequency	25 MHz

²⁴ 1 kHz, 50% duty cycle square wave. PFI 1 only.

Waveform Specifications

Table 3. Onboard Memory Size

Real-Time and RIS Modes	Real-Time TIS Mode
8 MB standard (8 MS) per channel	8 MB standard (8 MS)
64 MB option (64 MS) per channel	64 MB option (64 MS)
256 MB option (256 MS) per channel	256 MB option (256 MS)
512 MB option (512 MS) per channel	512 MB option (512 MS)

Minimum record length	1 sample
Number of pretrigger samples	Zero up to full record length
Number of posttrigger samples	Zero up to full record length
Maximum number of records in onboard memory ²⁶	
8 MB per channel	32,768
64 MB per channel	100,000
256 MB per channel	100,000
512 MB per channel	100,000
Allocated onboard memory per record	$[(\text{Record length} \times 1 \text{ byte/sample}) + 400 \text{ bytes}]$ rounded up to next multiple of 128 bytes

Calibration

External Calibration

External calibration calibrates the VCSO and the voltage reference. All calibration constants are stored in nonvolatile memory.

²⁵ Single-record mode and multiple-record mode.

²⁶ It is possible to exceed these numbers if you fetch records while acquiring data. For more information, refer to the *High-Speed Digitizers Help*.

Self-Calibration

Self-calibration is done on software command. The calibration corrects for gain, offset, triggering, and timing errors for all input ranges.

Calibration Specifications

Interval for external calibration	2 years
Warm-up time	15 minutes

Software

Driver Software

Driver support for the PXI-5152 was first available in NI-SCOPE 3.2.

NI-SCOPE is an IVI-compliant driver that allows you to configure, control, and calibrate the PXI-5152. NI-SCOPE provides application programming interfaces for many development environments.

Application Software

NI-SCOPE provides programming interfaces, documentation, and examples for the following application development environments:

- LabVIEW
- LabWindows™/CVI™
- Measurement Studio
- Microsoft Visual C/C++
- .NET (C# and VB.NET)

Interactive Soft Front Panel and Configuration

The NI-SCOPE Soft Front Panel (SFP) allows interactive control of the PXI-5152.

Interactive control of the PXI-5152 was first available in NI-SCOPE SFP version 3.2. The NI-SCOPE SFP is included on the NI-SCOPE media.

NI Measurement Automation Explorer (MAX) also provides interactive configuration and test tools for the PXI-5152. MAX is included on the NI-SCOPE media.

TClk Specifications

You can use the NI TClk synchronization method and the NI-TClk driver to align the Sample clocks on any number of supported devices, in one or more chassis. For more information about TClk synchronization, refer to the *NI-TClk Synchronization Help*, which is located within the *NI High-Speed Digitizers Help*. For other configurations, including multichassis systems, contact NI Technical Support at ni.com/support.

Intermodule SMC Synchronization Using NI-TCIk for Identical Modules

Synchronization specifications are valid under the following conditions:

- All modules are installed in one NI PXI-1042 chassis
- The NI-TCIk driver is used to align the Sample clocks of each module.
- All parameters are set to identical values for each module.
- Modules are synchronized without using an external Sample clock.
- Sample clock set to 1 GS/s and all filters are disabled.



Note Although you can use NI-TCIk to synchronize non-identical SMC-based modules, these specifications apply only to synchronizing identical modules.

Skew ²⁷	500 ps
--------------------	--------

Skew after manual adjustment	≤5 ps
------------------------------	-------

Sample clock delay/adjustment resolution	≤5 ps
--	-------

Power

Current draw

+3.3 VDC	1.1 A
----------	-------

+5 VDC	1.9 A
--------	-------

+12 VDC	500 mA
---------	--------

-12 VDC	210 mA
---------	--------

Total power	21.65 W
-------------	---------

Physical

Dimensions	3U, one-slot, PXI module 21.6 cm × 2.0 cm × 13.0 cm (8.5 in × 0.8 in × 5.1 in)
------------	--

Weight	462 g (16.3 oz)
--------	-----------------

²⁷ Caused by clock and analog path delay differences. No manual adjustment performed.

Figure 7. PXI-5152 Dimensions

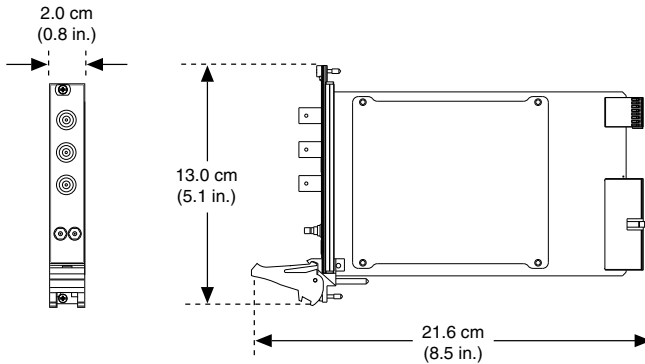

Environment

Environment

Maximum altitude	2,000 m (at 25 °C ambient temperature)
Pollution Degree	2

Indoor use only.

Operating Environment

Ambient temperature range	0 °C to 55 °C (Tested in accordance with IEC 60068-2-1 and IEC 60068-2-2.)
Relative humidity range	10% to 90%, noncondensing (Tested in accordance with IEC 60068-2-56.)

Storage Environment

Ambient temperature range	-40 °C to 71 °C (Tested in accordance with IEC 60068-2-1 and IEC 60068-2-2.)
Relative humidity range	5% to 95%, noncondensing (Tested in accordance with IEC 60068-2-56.)

Shock and Vibration

Operational shock	30 g peak, half-sine, 11 ms pulse (Tested in accordance with IEC 60068-2-27. Test profile developed in accordance with MIL-PRF-28800F.)
-------------------	---

Random vibration

Operating	5 Hz to 500 Hz, 0.31 g _{rms} (Tested in accordance with IEC 60068-2-64.)
Nonoperating	5 Hz to 500 Hz, 2.46 g _{rms} (Tested in accordance with IEC 60068-2-64. Test profile exceeds the requirements of MIL-PRF-28800F, Class 3.)

Compliance and Certifications

Safety

This product is designed to meet the requirements of the following electrical equipment safety standards for measurement, control, and laboratory use:

- IEC 61010-1, EN 61010-1
- UL 61010-1, CSA C22.2 No. 61010-1



Note For UL and other safety certifications, refer to the product label or the [Online Product Certification](#) section.

Electromagnetic Compatibility

This product meets the requirements of the following EMC standards for electrical equipment for measurement, control, and laboratory use:

- EN 61326-1 (IEC 61326-1): Class A emissions; Basic immunity
- EN 55011 (CISPR 11): Group 1, Class A emissions
- EN 55022 (CISPR 22): Class A emissions
- EN 55024 (CISPR 24): Immunity
- AS/NZS CISPR 11: Group 1, Class A emissions
- AS/NZS CISPR 22: Class A emissions
- FCC 47 CFR Part 15B: Class A emissions
- ICES-001: Class A emissions



Note In the United States (per FCC 47 CFR), Class A equipment is intended for use in commercial, light-industrial, and heavy-industrial locations. In Europe, Canada, Australia, and New Zealand (per CISPR 11), Class A equipment is intended for use only in heavy-industrial locations.



Note Group 1 equipment (per CISPR 11) is any industrial, scientific, or medical equipment that does not intentionally generate radio frequency energy for the treatment of material or inspection/analysis purposes.



Note For EMC declarations, certifications, and additional information, refer to the [Online Product Certification](#) section.

CE Compliance

This product meets the essential requirements of applicable European Directives, as follows:

- 2014/35/EU; Low-Voltage Directive (safety)
- 2014/30/EU; Electromagnetic Compatibility Directive (EMC)

Online Product Certification

Refer to the product Declaration of Conformity (DoC) for additional regulatory compliance information. To obtain product certifications and the DoC for this product, visit ni.com/certification, search by model number or product line, and click the appropriate link in the Certification column.

Environmental Management

NI is committed to designing and manufacturing products in an environmentally responsible manner. NI recognizes that eliminating certain hazardous substances from our products is beneficial to the environment and to NI customers.

For additional environmental information, refer to the *Minimize Our Environmental Impact* web page at ni.com/environment. This page contains the environmental regulations and directives with which NI complies, as well as other environmental information not included in this document.

Waste Electrical and Electronic Equipment (WEEE)



EU Customers At the end of the product life cycle, all NI products must be disposed of according to local laws and regulations. For more information about how to recycle NI products in your region, visit ni.com/environment/weee.

电子信息产品污染控制管理办法（中国 RoHS）



中国客户 National Instruments 符合中国电子信息产品中限制使用某些有害物质指令 (RoHS)。关于 National Instruments 中国 RoHS 合规性信息，请登录 ni.com/environment/rohs_china。(For information about China RoHS compliance, go to ni.com/environment/rohs_china.)

Information is subject to change without notice. Refer to the *NI Trademarks and Logo Guidelines* at ni.com/trademarks for information on NI trademarks. Other product and company names mentioned herein are trademarks or trade names of their respective companies. For patents covering NI products/technology, refer to the appropriate location: **Help»Patents** in your software, the `patents.txt` file on your media, or the *National Instruments Patent Notice* at ni.com/patents. You can find information about end-user license agreements (EULAs) and third-party legal notices in the `readme` file for your NI product. Refer to the *Export Compliance Information* at ni.com/legal/export-compliance for the NI global trade compliance policy and how to obtain relevant HTS codes, ECCNs, and other import/export data. NI MAKES NO EXPRESS OR IMPLIED WARRANTIES AS TO THE ACCURACY OF THE INFORMATION CONTAINED HEREIN AND SHALL NOT BE LIABLE FOR ANY ERRORS. U.S. Government Customers: The data contained in this manual was developed at private expense and is subject to the applicable limited rights and restricted data rights as set forth in FAR 52.227-14, DFAR 252.227-7014, and DFAR 252.227-7015.

© 2008—2019 National Instruments. All rights reserved.

374443J-01 April 17, 2019